

# ACCESSORIES AND SPARE PARTS



ACCESSORIES AND SPARE PARTS FOR PRODUCTS IN THE VARIOUS LINES.



## RAPID/GET • SPRAYING LANCE



Model	Code	Min. q.ty
Curved Rapid/Get lance 61 cm	1611/1C	5
Curved Rapid/Get lance 61 cm - Blister	1611/1CBLIS	5

## SPRAY/GET • SPRAYING LANCE



Model	Code	Min. q.ty
Curved Spray/Get lever lance 60 cm	163	5
Curved Spray/Get lever lance 60 cm - Blister	163BLIS	5

## UNIVERSAL/GET • SPRAYING LANCE



Model	Code	Min. q.ty
Universal/Get lance 70 cm	1614/1	5
Universal/Get lance 70 cm - Blister	1614/1BLIS	5

## HOBBY/VOLPITECH • SPRAYING LANCE



163P



163PV

Model	Code	Min. q.ty
Plastic lever lance mod. Hobby 60 cm	163P	5
Plastic lever lance mod. Hobby 60c m - Blister	163PBLIS	5
Plastic lever lance mod.Industrial Volpitech 60 cm	163PV	5
Plastic lever lance mod. Industrial Volpitech 60 cm - Blister	163PVBLIS	5

## CLICK/GET • SPRAYING LANCE



164

Model	Code	Min. q.ty
Click/Get lance 80 cm	164	5
Click/Get lance 80 cm - Blister	164BLIS	5

## TELESCOPIC • SPRAYING LANCE



1615/1



163PT

Model	Code	Min. q.ty
Telescopic lance 0.75-1.25 m with Get nozzle	1615/1	5
Telescopic lever lance 0.67-1.10 m with Get nozzle	163PT	5

## SPRAYING LANCE • BRASS

WITH SPHERE TAP



1620/1

Model	Code	Min. q.ty
Lance with sphere tap and Get nozzle 68 cm	1620/1	5
Lance with sphere tap and Get nozzle 68 cm - Blister	1620/1BLIS	5

## CURVED LEVER LANCES FOR POLLINATION



1607



1608



927R10RM



927R30RM

Model	Code	Min. q.ty
Plastic handle and special steerable nozzle for pollination	1607/1L	5
40 cm curved lever lance for pollination with plastic handle and special steerable nozzle for pollination	1607/2L	5
60 cm curved lever lance for pollination with brass handle and special steerable nozzle for pollination	1608/1L	5
40 cm curved lever lance for pollination with brass handle and special steerable nozzle for pollination	1608/2L	5
40 cm curved aluminium pole with nozzle for pollination	927R10RM	5
20 cm curved aluminium pole with nozzle for pollination	927R30RM	5

## NOZZLE FOR POLLINATION



208

Model	Code	Min. q.ty
Nozzle for pollination with universal connection with $\varnothing$ 8 hole	208	10

## PROTECTIVE HOOD



300

Model	Code	Min. q.ty
Protective hood	300	5
Anti-drip valve with filter	ZZ1941A	10
Yellow fan nozzle (2 bar l/min.0,65)	ZZ1941G	10
Plastic ring 3/8	PL01C02	10
30° joint with ring for protective hood	30D5	5
Nozzle complete with sleeve and ring nut	30D6	10



Q.ty: PIECES 5  
Dim.(cm): 40x30x34  
Weight (kg): 2,300



Q.ty: PIECES 200

## EXTENSION POLE IN ALUMINIUM, BRASS AND STAINLESS STEEL



Model	Code	Min. q.ty
Aluminium extension pole $\varnothing$ 10 50 cm	190/1	10
Aluminium extension pole $\varnothing$ 10 50 cm - Blister	190/1BLIS	5
Aluminium extension pole $\varnothing$ 10 70 cm	190/2	10
Brass extension pole $\varnothing$ 10 50 cm	189/1	10
Brass extension pole $\varnothing$ 10 50 cm - Blister	189/1BLIS	5
Brass extension pole $\varnothing$ 10 70 cm	189/3	10
O-ring for end fittings	ZZ0R108	10
Curved stainless steel extension pole $\varnothing$ 10 75 cm	187R2C	10
Curved aluminium pole $\varnothing$ 8 40 cm	1612R1C	5
Aluminium pole $\varnothing$ 8 60 cm	1612R2C	5
Curved stainless steel extension pole $\varnothing$ 10 75 cm - Blister	187R2CBLIS	5
Connection for curved stainless steel pole / Elettropius handle	165/18	10

## TELESCOPIC EXTENSION AND 3/8 BRASS FITTING



1612R



Model	Code	Min. q.ty
Telescopic extension 55 cm to 100 cm with brass fitting	189T	5
3/8 brass fitting for handles 1612A, 1612AL, 1619, 1692, 196, 193	1612R	10

## EXTENSION POLE FOR GREEN FOX

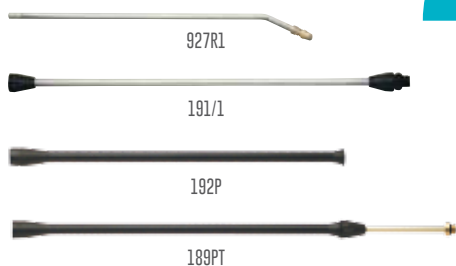

927R1

191/1

192P

189PT

Model	Code	Min. q.ty
Aluminium pole 40 cm with adjustable miniget	927R1	10
Aluminium extension pole $\varnothing$ 10 50 cm with fittings	191/1	10
Plastic extension pole 42 cm	192P	10
Telescopic extension pole 50/90 cm	189PT	10

## 3M TELESCOPIC EXTENSION

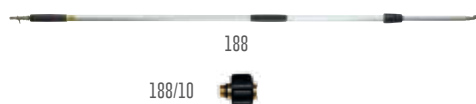

188/10



Model	Code	Min. q.ty
Telescopic extension 1.5-3.0 m with tap	188	1
Connection for telescopic extension 1.5-3.0 m / Elettropius handle	188/10	10

## CLICK HANDLE



163R

Model	Code	Min. q.ty
Lever click handle	163R	10
Lever click handle - Blister	163RBLIS	10



## PLASTIC HANDLE

Model	Code	Min. q.ty
Rapid lever handle	1611AL	10
Plastic lever handle "Rondinella" with brass fitting	1612AL	10
Rapid handle	1611A	10
Rapid handle - Blister	1611ABLIS	5
Universal handle	1612A	10
Universal handle - Blister	1612ABLIS	5
Universal fitting	1612E	10
Brass hose fitting with O-ring for Rapid and Universal handle	1612PG	10

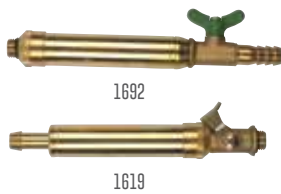

## HANDLE WITH SPHERE TAP

Model	Code	Min. q.ty
UNI handle with filter	1692	5
Handle with sphere tap	1619	5
Handle with sphere tap - Blister	1619BLIS	5

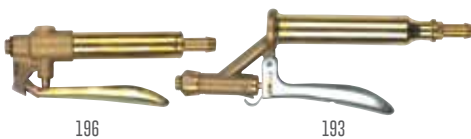

## LEVER HANDLE WITH TAP

Model	Code	Min. q.ty
Lever handle "Stella" with tap and filter	196	5
Lever handle "Stella" with tap and filter - Blister	196BLIS	5
Lever handle with tap and filter	193	5



## STEERABLE NOZZLES

Model	Code	Min. q.ty
"Maxi" nozzle with $\varnothing$ 1.3 hole	214	10
"D.T." nozzle with $\varnothing$ 1.3 hole	213	10
"D.T." cap with $\varnothing$ 1.3 hole	215	10

## STEERABLE NOZZLES



930A



928



930

Model	Code	Min. q.ty
"GET" steerable nozzle with $\varnothing$ 1.5 hole	928	10
"GET" steerable nozzle with $\varnothing$ 1.5 hole - Blister	928BLIS	5
"MEC" steerable nozzle with ceramic plate with $\varnothing$ 1.0 hole	930/10	10
"MEC" steerable nozzle with ceramic plate with $\varnothing$ 1.2 hole	930/12	10
"MEC" steerable nozzle with ceramic plate with $\varnothing$ 1.5 hole	930/15	10
Ceramic plate with $\varnothing$ 1.0 hole	930B10	10
Ceramic plate with $\varnothing$ 1.2 hole	930B12	10
Ceramic plate with $\varnothing$ 1.5 hole	930B15	10
O-ring gasket 3043	ZZOR3043	10
Ring nut	930A	5

## FIXED NOZZLES



219/2



222A



229



930A



220



222B

Model	Code	Min. q.ty
"RILEY" nozzle with 2-hole body	219/2	10
Riley cap with $\varnothing$ 1.5 hole	222A	10
Rose nozzle with ceramic plate with $\varnothing$ 1.0 hole	229/10	10
Rose nozzle with ceramic plate with $\varnothing$ 1.2 hole	229/12	10
Rose nozzle with ceramic plate with $\varnothing$ 1.5 hole	229/15	10
Ceramic plate with $\varnothing$ 1.0 hole	930B10	10
Ceramic plate with $\varnothing$ 1.2 hole	930B12	10
Ceramic plate with $\varnothing$ 1.5 hole	930B15	10
Plastic conveyor	930D	10
O-ring gasket 3043	ZZOR3043	10
"MERIDIONALE" nozzle with 2-hole body	220	10
Meridionale cap with $\varnothing$ 1.3 hole	222B	10
Ring nut	930A	5

## BI/TRIWAY NOZZLES



223C



223



224



224C



203



226A



226B

Model	Code	Min. q.ty
Double nozzle	223	5
Curved double nozzle	223C	5
Triple nozzle	224	5
Curved triple nozzle	224C	5
Elbow fitting	203	10
Brass elbow fitting with gasket - Blister	203BLIS	5
Piemonte cap with $\varnothing$ 1.2 hole	226A	10
Piemonte propeller	226B	10

## FAN NOZZLES



Model	Code	Min. q.ty
"American" type fan nozzle	217	10
"AILA" fan nozzle with blue internal fan nozzle (2 bar lt/min.1.00)	218	10
"AILA" fan nozzle with blue internal fan nozzle (2 bar lt/min.1.00) - Blister	218BLIS	5
Blue fan nozzle (2 bar lt/min. 1.00)	ZZ1941B	10
Magenta fan nozzle (2 bar lt/min. 0.82)	ZZ1941M	10
Yellow fan nozzle (2 bar lt/min. 0.65)	ZZ1941G	10
Green fan nozzle (2 bar lt/min. 0.50)	ZZ1941V	10
Ring nut	930A	5

## TAP

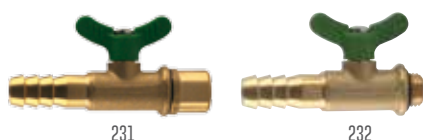

Model	Code	Min. q.ty
Female tap with thread	231	10
Male tap with thread	232	10

## FITTINGS



Model	Code	Min. q.ty
Female terminal fitting	199	10
Male terminal fitting	200	10
Fitting with two male threads (1/4 Gas step downy mildew)	201	10

## HOSE FITTINGS



Model	Code	Min. q.ty
<b>Double joint with finned ring hose pitch step 1/2 gas:</b>		
For hoses $\varnothing$ 8	252A8	10
For hoses $\varnothing$ 10	252A10	10
1/2" Nipple	252/1	10
<b>3-piece fitting with 1/2" ring hose for hoses:</b>		
mm. $\varnothing$ 8	254/8	5
mm. $\varnothing$ 10	254/10	5
<b>One-piece fitting for hoses:</b>		
mm. $\varnothing$ 8	731/8	10
mm. $\varnothing$ 10	731/10	10

## COMPLETE HEAD FOR LANCE

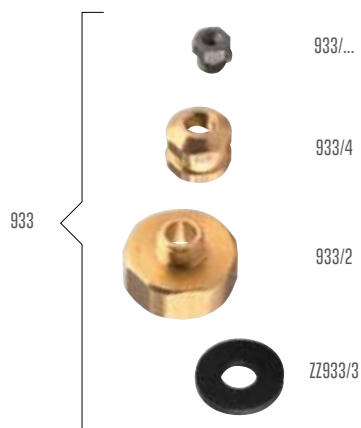

Model	Code	Min. q.ty
Complete head for lance 174 and 180	933	5
Cap	933/2	10
Gasket	ZZ933/3	10
Nozzle support	933/4	10
Stainless steel nozzle with $\emptyset$ 1.0 hole	933/10	10
Stainless steel nozzle with $\emptyset$ 1.2 hole	933/12	10
Stainless steel nozzle with $\emptyset$ 1.5 hole	933/15	10
Stainless steel nozzle with $\emptyset$ 1.8 hole	933/18	10
Stainless steel nozzle with $\emptyset$ 2.0 hole	933/20	10
Stainless steel nozzle with $\emptyset$ 2.5 hole	933/25	10

## 1/2" HOSE FITTING



Model	Code	Min. q.ty
Hose fitting with 1/2 gas finned fitting for $\emptyset$ 8 hoses	234B8	10
Hose fitting with 1/2 gas finned fitting for $\emptyset$ 10 hoses	234B10	10
Hose fitting with 1/2 gas finned fitting for $\emptyset$ 13 hoses	234C13	10
Elbow hose fitting with 1/2 gas finned fitting $\emptyset$ 10	234D	10
Flat gasket 1/2 gas 18x12x2	Y6UP18	10

## FAN NOZZLE WITH FILTER

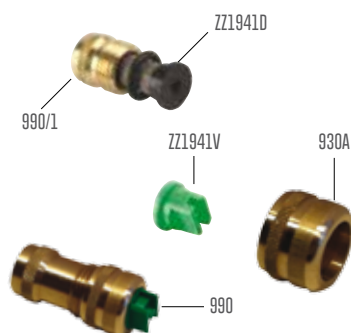

Model	Code	Min. q.ty
Fan nozzle with filter	990	5
Ring nut	930A	5
Fan nozzle	ZZ1941V	5
Filter	ZZ1941D	5
Nozzle body	990/1	5

## MIRROR NOZZLES



Model	Code	Min. q.ty
Mirror nozzle with DH2 nozzle	950	10
Ring nut	930A	10
Mirror nozzle	TK2	10
O-ring seal	ZZOR3043	10
3/8" Fitting	1612R	10





197C

## FILTER FOR HANDLES

Model	Code	Min. q.ty
Filter for handles DT & UNI	197C	10



234A

## 3/8" HOSE FITTING

Model	Code	Min. q.ty
Hose fitting with 3/8 gas finned fitting for Ø 8 hoses	234A8	10
Hose fitting with 3/8 gas finned fitting for Ø 10 hoses	234A10	10
Flat gasket 3/8 gas 15.5x10x2	YGUP15	10

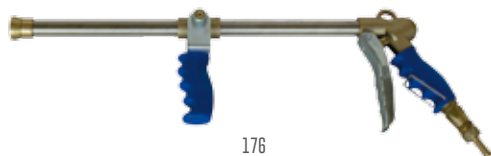

176

## MITRA LANCE FOR HIGH PRESSURE

Model	Code	Min. q.ty
Mitra lance for high and very high pressure with nozzle Ø 2.0	176	1
Ceramic nozzle for Mitra and Jet lance Ø 1,0	176W10	1
Ceramic nozzle for Mitra and Jet lance Ø 1,2	176W12	1
Ceramic nozzle for Mitra and Jet lance Ø 1,5	176W15	1
Ceramic nozzle for Mitra and Jet lance Ø 1,8	176W18	1
Ceramic nozzle for Mitra and Jet lance Ø 2,0	176W20	1
Ceramic nozzle for Mitra and Jet lance Ø 2,5	176W25	1
Ceramic nozzle for Mitra and Jet lance Ø 3,0	176W30	1
Ceramic nozzle for Mitra and Jet lance Ø 3,5	176W35	1
Nylon closing insert 176/18	176/18	1



177

## MITRA ECO LANCE FOR HIGH PRESSURE

Model	Code	Min. q.ty
Mitra Eco lance for high and very high pressure with nozzle Ø 2.0	177	1



179

## JET LANCE JET LANCE

Model	Code	Min. q.ty
Jet lance for high pressure Ø 2.0	179	1

## FOX LANCE FOR HIGH PRESSURE

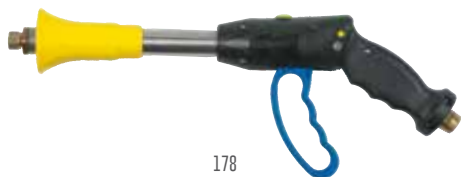

178

Model	Code	Min. q.ty
Fox lance for high pressure with nozzle $\varnothing$ 2.0 equipped with two spare nozzles with hole $\varnothing$ 1.8 and hole $\varnothing$ 2.5	178	1
Ceramic nozzle for Fox lance $\varnothing$ 1.8	178/1	1
Nozzle support for Fox lance	178/2	1
Nozzle $\varnothing$ 1.0 + support + gasket for Fox lance	178K10	1
Nozzle $\varnothing$ 1.2 + support + gasket for Fox lance	178K12	1
Nozzle $\varnothing$ 1.5 + support + gasket for Fox lance	178K15	1
Nozzle $\varnothing$ 1.8 + support + gasket for Fox lance	178K18	1
Nozzle $\varnothing$ 2.0 + support + gasket for Fox lance	178K20	1

## LEVER LANCE



174/60

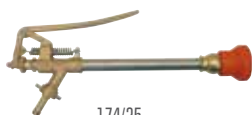

174/25

Model	Code	Min. q.ty
Steerable lever lance for high pressure approx. 60 cm with nozzle $\varnothing$ 1.5	174/60	1
Steerable lever lance for high pressure approx. 25 cm with nozzle $\varnothing$ 1.5	174/25	1
Lance diffuser for high pressure with nozzle $\varnothing$ 1.2	174D12	1
Lance diffuser for high pressure with nozzle $\varnothing$ 1.5	174D15	1

## LANCE WITH HANDLE



180/65



180/30

Model	Code	Min. q.ty
Steerable lance with handle for high pressure approx. 65cm with nozzle $\varnothing$ 1.5	180/65	1
Steerable lance with handle for high pressure approx. 30cm with nozzle $\varnothing$ 1.5	180/30	1
Lance diffuser for high pressure with nozzle $\varnothing$ 1.2	174D12	1
Lance diffuser for high pressure with nozzle $\varnothing$ 1.5	174D15	1

## PVC HOSE

WITH NYLON INSERTS FOR KNAPSACK AND COMPRESSION SPRAYERS (ROLLS OF 50 METERS)



PVC10

Model	Code	Min. q.ty (m)
PVC hose $\varnothing$ 7x12	PVC10	50
Model	Code	Min. q.ty
PVC hose sections 120 cm	PVC120	10
PVC hose sections 150 cm	PVC150	10
PVC hose sections 120 cm - Blister	PVC120BLIS	10
PVC hose sections 150 cm - Blister	PVC150BLIS	10



TP1040

TP825

## HIGH PRESSURE PLASTIC HOSE WITH HIGH PRESSURE CANVAS (IN 50 METRE ROLLS)

Model	Code	Min. q.ty (m)
High pressure hose 8x13; 20 bar	TP825	50
High pressure hose 10x17; 40 bar	TP1040	50



1342

## EDILE SPRAYER

- PROFESSIONAL BRASS PUMP
- PEAK PRESSURE 8 BAR
- SUCTION RUBBER HOSE
- PLASTIC FILTER
- NET PUMP WEIGHT 5KG APPROX.
- IDEAL FOR SPRAYING LIME AND OTHER WATER-BASED PRODUCTS ONTO WALLS

Model	Code	Min. q.ty
Edile sprayer	1342	1

spare parts on page 68



310/40 310/25

## PLASTIC STRAP WITH NYLON INSERT

Model	Code	Min. q.ty (m)
Plastic strap with nylon inserts 40mm wide per m	310/40	50
Plastic strap with nylon inserts 25mm wide per m	310/25	50

## HOSE CLAMP FOR RUBBER HOSE



Model	Code	Min. q.ty
from mm 9 to mm 17	ZZ314/9	100
from mm 14 to mm 22	ZZ314/14	50
from mm 20 to mm 30	ZZ314/20	50
from mm 24 to mm 44	ZZ314/24	50
from mm 47 to mm 67	ZZ314/47	50
from mm 62 to mm 82	ZZ314/62	50
from mm 77 to mm 97	ZZ314/77	25