

## PREFERRED LIQUIDS

Use only liquids which are naturally sweetened and naturally flavoured. Artificially flavoured and artificially sweetened drinks may not work.

Avoid using cola or artificial fizzy drinks. Use only liquids that you know attract wasps.

Fruit juices work well if they contain the aromatic parts of the fruit. Orange (or other citrus) juice, especially from concentrate, may not be effective without the aromatic oils from the peel.

Good results have been achieved using a mix of equal parts sweet beer or lager mixed with equal parts of water to which is added about 100g of honey.

Do not use bitter beers.

Good results have also been achieved using pureed overripe whole fruit for example equal parts white and black grapes with one nectarine and about 100g honey.

Add water as required so that the liquid can be poured.

DO NOT use peppermint cordial or oil.

## INSTRUCTIONS FOR USE OF LIQUID

Add a sufficient amount of the preferred liquid (about 900ml) to the bait chamber to take the level of the liquid up to the fill level indicated on the label.

DO NOT FILL TO THE SAFE CAPACITY LEVEL.

Swirl the bait chamber in the upright position using the displaced funnel tube as an agitator to help mix the powders into the bait liquid.

The resulting bait will vary in appearance and the activator may form a froth or slight scum line and this is quite normal.

## SEASON

The nuisance season for wasps will vary depending on climate and geography but normally begins around mid summer and then peaks in late summer and early autumn.

The WaspBane wasp trap should not be set in early spring for ecological reasons. If set too early in summer the trap may appear to be inactive as it only catches wasps once they develop their sweet tooth towards mid to late summer.

Setting a trap too early should not affect how the trap works in the long term but it may take a while before wasps are caught.

## MORE INFORMATION

More detailed information is available on the WaspBane website, [www.waspbane.com](http://www.waspbane.com) including frequently asked questions in the contact section.

Made in England

Patent No.: EP1399017



## INSTRUCTIONS FOR ASSEMBLING AND BAITING THE WASPBANE® WASP TRAP

Please follow all instructions carefully before use

**PLEASE NOTE: THE POWDERS PROVIDED WITH THIS TRAP ARE NOT AN ATTRACTANT. THEY ARE A PRESERVATIVE SYSTEM DESIGNED TO KEEP THE LIQUID BAIT THAT YOU ADD TO THE TRAP FRESH SO THAT THE TRAP CAN CONTINUE WORKING THROUGHOUT THE WASP SEASON**

It is strongly recommended that the trap is not set before mid summer (see section on season)

Copyright© WaspBane 2021

### SAFETY NOTICE

WHILST THE MANUFACTURERS OF WASPBANE ENDEAVOUR TO ACT RESPONSIBLY TO PROTECT THE SAFETY OF THE USERS OF THE WASPBANE WASP TRAP, USERS OF THE WASPBANE WASP TRAP DO SO AT THEIR OWN RISK

THE MANUFACTURERS OF WASPBANE ACCEPT NO RESPONSIBILITY OR LIABILITY FOR THE SAFETY OF ANY PERSON USING THE WASPBANE WASP TRAP

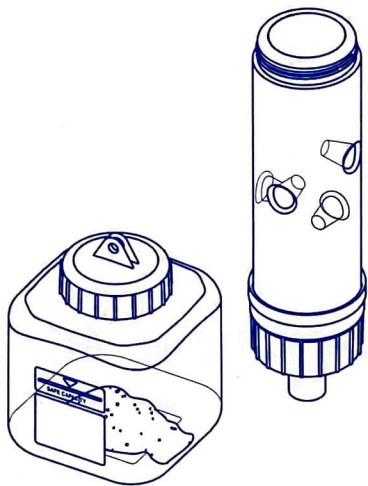
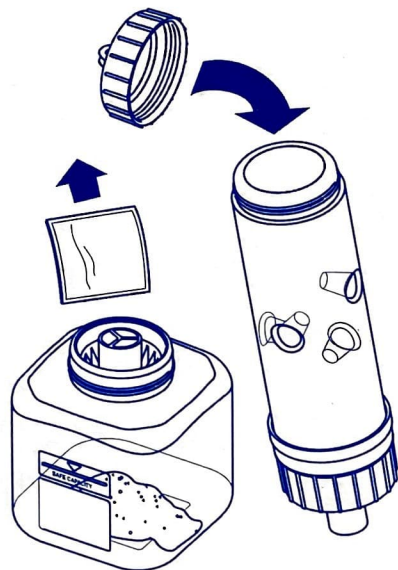
**1****2****3**

Open safety seal using funnel tube taking care not to push the funnel tube right through the safety seal.

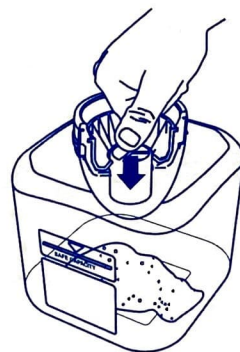
**4**

Add activator before adding chosen liquid.

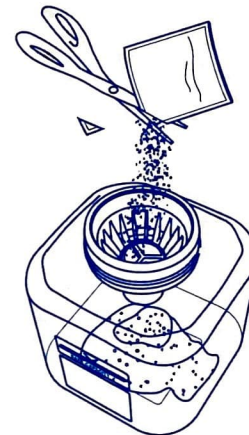
**5**

Add liquid to 'Approx Fill Level' indicated on the label. DO NOT fill to safe capacity mark.

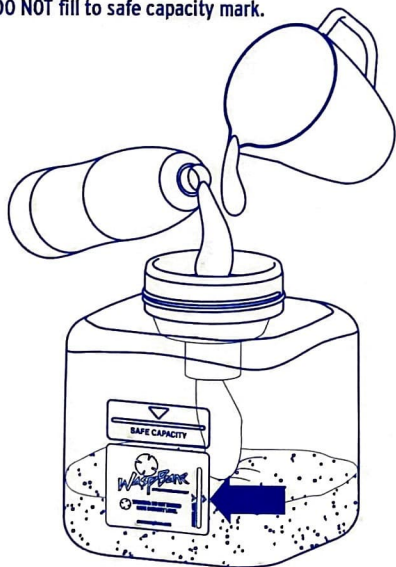
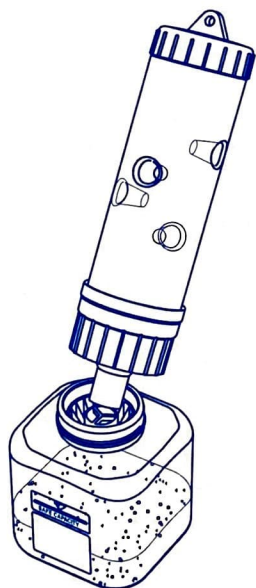
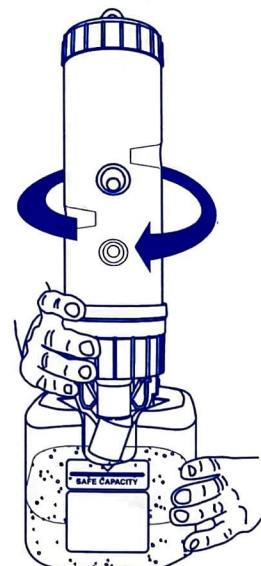
**6****7****8**

Swirl to mix

