

ORIGINALE
VOLPI



M I C R O N I Z E R S



THE EXTRAORDINARY HERBICIDE SYSTEM, PURE OR DILUATED AT LOW WATER VOLUME, IN A POSITION TO OFFER A HIGH WORK QUALITY, MAXIMUM LIGHTNESS AND EASY USE FOR THE END USER.



Hood Ø 34cm

M3000 • ELECTRIC MICRONIZER WITH PROTECTIVE HOOD Ø 34 CM

- TO BE USED WITH PURE, UNDILUATED HERBICIDE
- TANK CAPACITY 1 LT
- HD POLYETHYLENE TANK
- GRAVITY-FED PRODUCT
- DROPS Ø 250 MICRON
- OPERATES WITH TWO 1.5V BATTERIES FOR 40 HOURS APPROX.
- OPERATING ANGLE ADJUSTMENT
- COVERAGE AREA Ø 34CM
- 0.6 M TUBE
- HOOD Ø 34 CM
- NET WEIGHT 2.0 KG APPROX.
- SUITABLE FOR PURE HERBICIDE SPOT CONTROL

Model	Code	Min. q.ty
Micronizer with protective hood Ø 34cm	M3000	1



Q.ty: PIECES 1
Dim.(cm): 35x16x108
Weight (kg): 2,000



Q.ty: PIECES 42

spare parts on page 70

FOR PURE,
UNDILUATED HERBICIDE

DROPS Ø 250 MICRON



HANDLE WITH SWITCH



DIFFUSER WITH PROTECTION

M2000 • ELECTRIC MICRONIZER WITHOUT PROTECTIVE HOOD

- TO BE USED WITH PURE, UNDILUATED HERBICIDE
- TANK CAPACITY 1 LT
- HD POLYETHYLENE TANK
- GRAVITY-FED PRODUCT
- DROPS Ø 250 MICRON
- OPERATES WITH TWO 1.5V BATTERIES FOR 40 HOURS APPROX.
- OPERATING ANGLE ADJUSTMENT
- COVERAGE AREA Ø 120CM
- 1M FOLDING TUBE
- DIFFUSER
- NET WEIGHT 1.6 KG APPROX.
- SUITABLE FOR PURE HERBICIDE WIDESPREAD CONTROL

Model	Code	Min. q.ty
Micronizer without protective hood	M2000	1



Q.ty: PIECES 1
Dim.(cm): 26x14x86
Weight (kg): 1,600



Q.ty: PIECES 60

spare parts on page 70

FOR PURE,
UNDILUATED HERBICIDE

DROPS Ø 250 MICRON



HANDLE WITH SWITCH

JOLLY • ELECTRIC MICRONIZER



- TO BE USED WITH HERBICIDE DILUATED IN WATER - LOW VOLUME
- TANK CAPACITY 10 LT
- HD POLYETHYLENE TANK
- GRAVITY-FED PRODUCT
- DROPS Ø 250 MICRON
- OPERATES WITH TWO 1.5V BATTERIES FOR 40 HOURS APPROX.
- OPTIONAL RECHARGEABLE LITHIUM BATTERY AND CHARGER, LOW WEIGHT, RAPID CHARGE
- OPTIONAL LITHIUM BATTERY RECHARGEABLE 150 TIMES WITHOUT REPLACEMENT
- OPERATING ANGLE ADJUSTMENT
- COVERAGE AREA FROM Ø 110 CM TO Ø 150 CM
- 1.2 M FOLDING TUBE
- DIFFUSER
- NET WEIGHT 1.7 KG APPROX.
- SUITABLE FOR DILUATED HERBICIDE WIDESPREAD CONTROL



DIFFUSER WITH PROTECTION

Model	Code	Min. q.ty
Jolly electric micronizer	M10V	5
Optional		
Rechargeable lithium battery kit with charger	M10V/01	1



Q.ty: PIECES 5
Dim.(cm): 146x44x23
Weight (kg): 8,500



Q.ty: PIECES 80

spare parts on page 71



10L TANK FOR DILUATED HERBICIDE



DROPS Ø 250 MICRON



ERGONOMIC HANDLE



RECHARGEABLE LITHIUM BATTERY KIT WITH CHARGER FOR M10V/01



RECHARGEABLE LITHIUM BATTERY KIT WITH CHARGER FOR M10V/01



ACCESSORIES AND SPARE PARTS



ACCESSORIES AND SPARE PARTS FOR PRODUCTS IN THE VARIOUS LINES.



M3000 AND M2000

ELECTRIC MICRONIZER

WITH HOOD

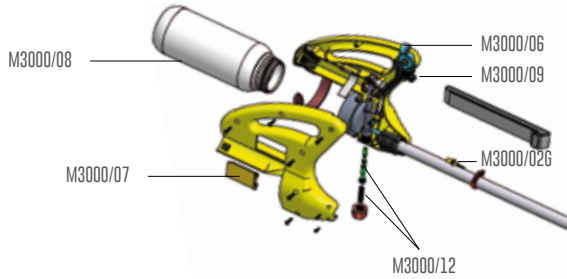

WITHOUT HOOD

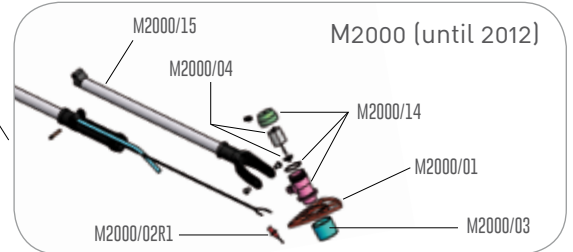
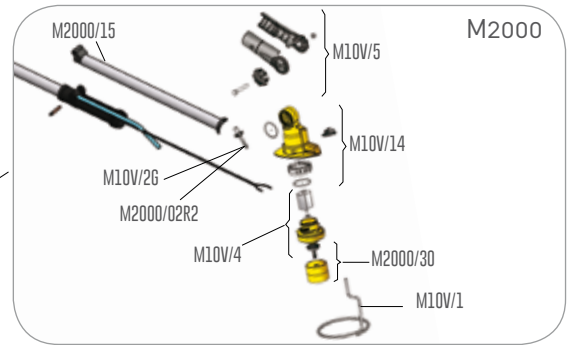
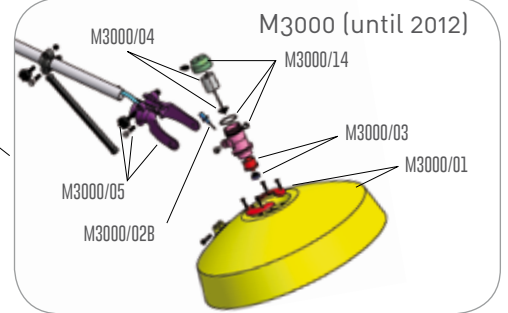
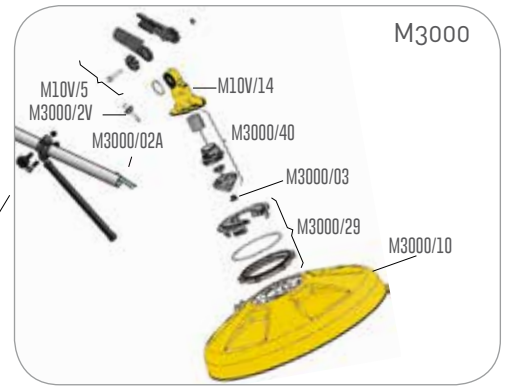
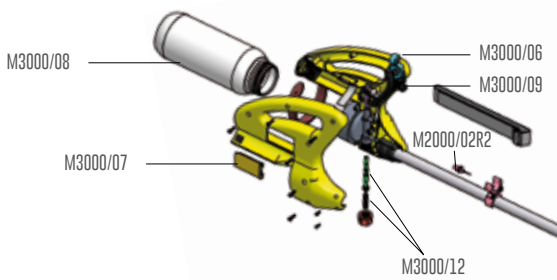

M3000 / M3000 (UNTIL 2012)

Q.ty	Code	Description
1	M10V/5	Complete joint
1	M10V/14	Motor support
1	M3000/01	Protective hood M3000
1	M3000/02A	Orange nozzle M3000 (Ø 1.0)
1	M3000/02B	Blue nozzle M3000 (Ø 1.1) (until 2012)
1	M3000/02G	Yellow nozzle M3000 (Ø 1) (until 2012)
1	M3000/02V	Green nozzle M3000 (Ø 0.8)
1	M3000/03	Diffuser disc M3000
1	M3000/04	Motor 3H034123 with gasket M3000
1	M3000/05	Complete joint for M3000
1	M3000/06	ON-OFF switch M3000
1	M3000/07	Battery compartment cover for M3000
1	M3000/08	1 Liter tank
1	M3000/09	Switch block M3000
1	M3000/10	Protective hood Ø 35
1	M3000/12	Liquid opening valve M3000
1	M3000/14	Complete motor support
1	M3000/29	Hood fixing kit M3000
1	M3000/40	Motor for M3000

M2000 / M2000 (UNTIL 2012)

Q.ty	Code	Description
1	M10V/1	Protection ring
1	M10V/26	Yellow nozzle
1	M10V/4	Complete motor
1	M10V/5	Complete joint
1	M10V/14	Motor support
1	M2000/01	Protection ring M2000
1	M2000/02R1	Red nozzle M2000 (one tooth Ø 1.2) (until 2012)
1	M2000/02R2	Red nozzle M2000 (two teeth Ø 1.4) (until 2012)
1	M2000/02M	Brown nozzle M2000 Ø 1.4
1	M2000/02N	Black nozzle M2000 Ø 1.6
1	M2000/03	Diffuser disc M2000
1	M2000/04	Motor 3F301323 with gasket M2000
1	M2000/14	Complete motor support M2000
1	M2000/15	Folding arm M2000
1	M2000/30	Diffuser disc

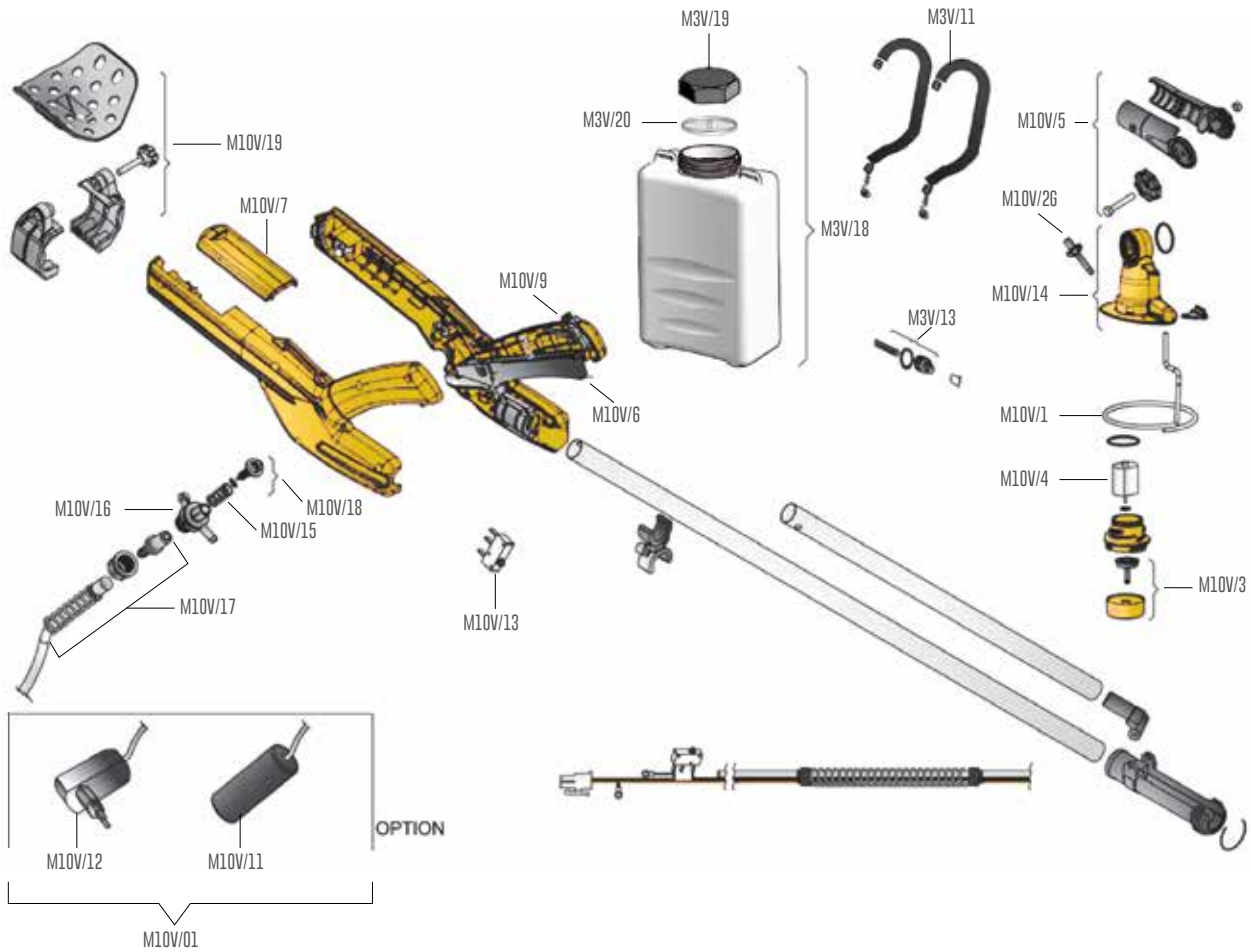

Q.ty	Code	Description	Q.ty	Code	Description
1	M10V/1	Protection ring M10V	1	M10V/5	Complete joint M10V
1	M10V/01	Rechargeable lithium battery kit with charger	1	M10V/6	Actuation lever M10V
1	M10V/11	Lithium battery M10V	1	M10V/7	Battery compartment cover M10V
1	M10V/12	Battery charger for lithium battery M10V	1	M10V/9	Block lever M10V
1	M10V/13	Micro-switch M10V	1	M3V/11	Pair of complete shoulder straps
1	M10V/14	Motor support M10V	1	M3V/13	Filter with fitting
1	M10V/15	Valve spring M10V	1	M3V/18	Complete tank for liquids with opening Ø 10
1	M10V/16	Tap for liquid M10V	1	M3V/19	Tank cover opening Ø 10
1	M10V/17	Liquid valve M10V	1	M3V/20	Filter for tank with opening Ø 10
1	M10V/18	Tap set M10V			
1	M10V/19	Arm support M10V			
1	M10V/26	Yellow nozzle M10V Ø 1.0			
1	M10V/2B	Blue nozzle M10V Ø 1.2			
1	M10V/3	Filter with fitting			
1	M10V/4	Complete motor M10V			

MICRONIZZATORE M3V

ELECTRIC FOR HERBICIDE

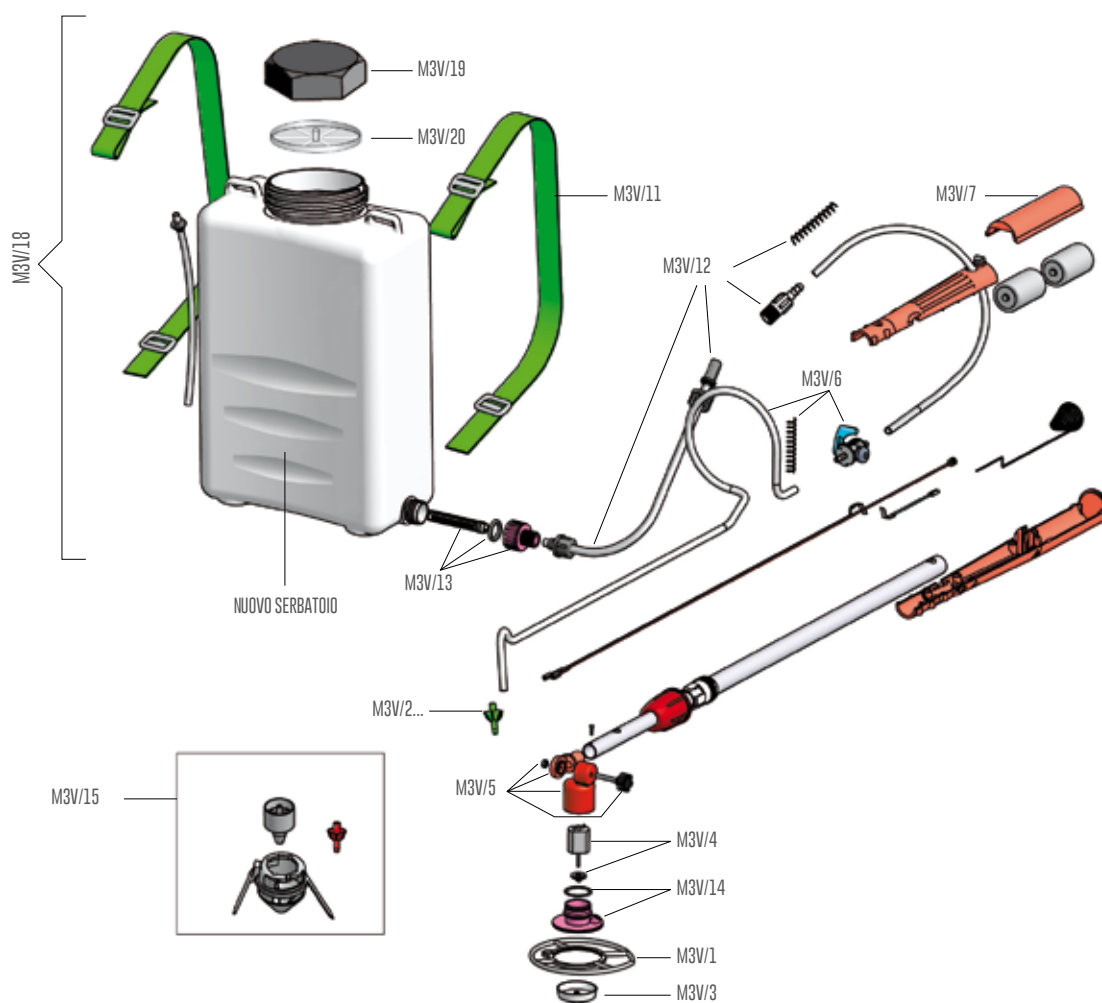

Q.ty	Code	Description	Q.ty	Code	Description
1	M3V/1	Protection ring for micronizer	1	M3V/11	Pair of complete shoulder straps
1	M3V/2V	Green nozzle for micronizer \varnothing 1.6 standard - Flow rate cc/min. 150	1	M3V/12	Check valve complete with connecting pipes
1	M3V/2G	Yellow nozzle for micronizer \varnothing 1.8 on request - Flow rate cc/min. 200	1	M3V/13	Filter with fitting
1	M3V/2B	Blue nozzle for micronizer \varnothing 2.2 on request - Flow rate cc/min. 300	1	M3V/14	Motor support
1	M3V/2N	Black nozzle for micronizer \varnothing 2.5 standard - Flow rate cc/min. 400	1	M3V/15	Sector kit
1	M3V/3	Diffuser disc for micronizer	1	M3V/18	Complete tank for liquids with opening \varnothing 10
1	M3V/4	Motor 3H033123 with gasket	1	M3V/19	Cover for tank with opening \varnothing 10
1	M3V/5	Complete joint	1	M3V/20	Filter for tank with opening \varnothing 10
1	M3V/6	Switch complete with tube			
1	M3V/7	Battery compartment cover for micronizer			